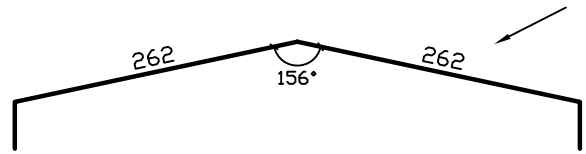
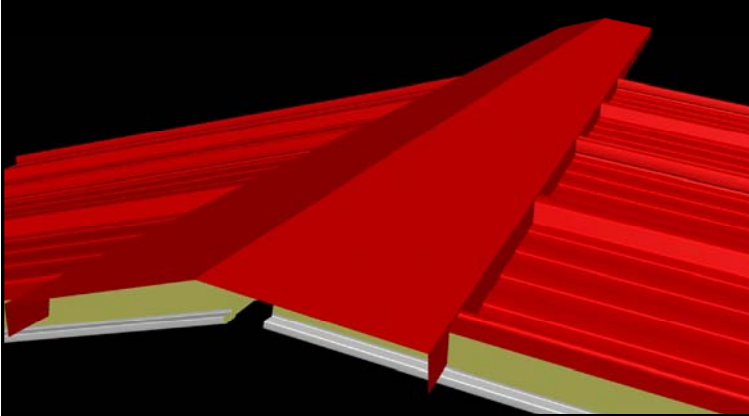
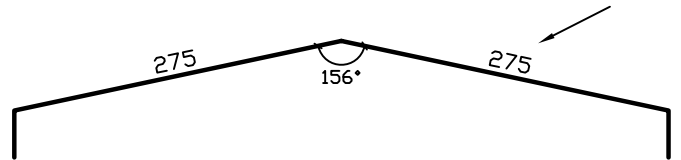
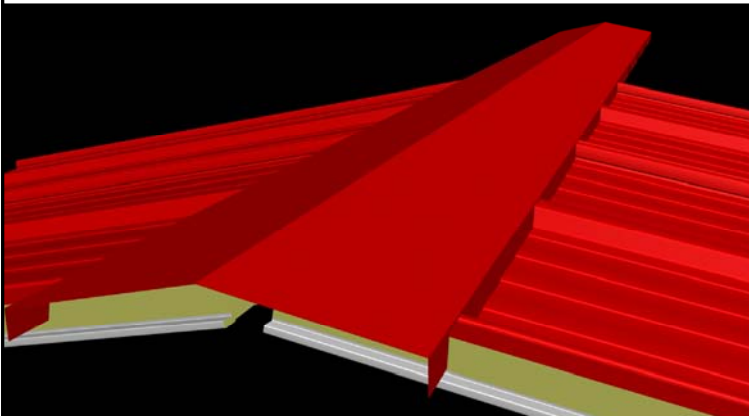
 panelais

REMATES

CUMBRERA TROQUELADA AIS TAP/3G/5G

DESARROLLO	600
LARGO	3200
OBS.	LARGO UTIL 3000

CUMBRERA SIN TROQUELAR

DESARROLLO	625
LARGO	HASTA 6000
OBS.	CAJEAR EN OBRA

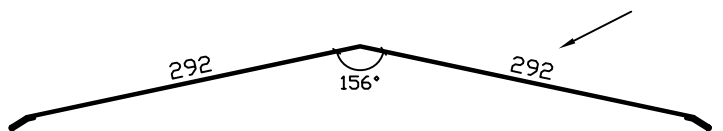
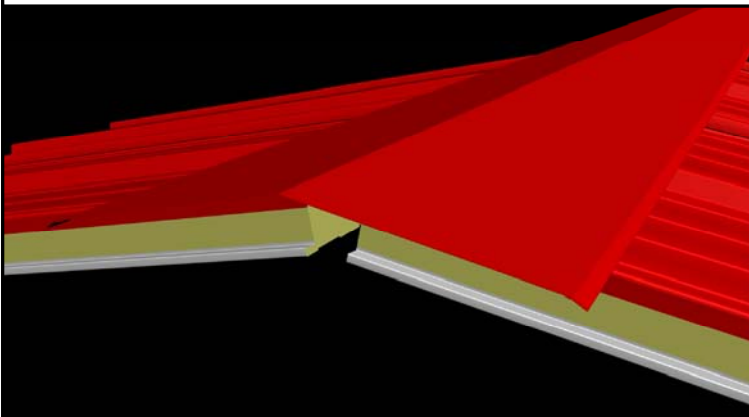
CUMBRERA LISA D625

DESARROLLO	625
LARGO	HASTA 6000
OBS.	

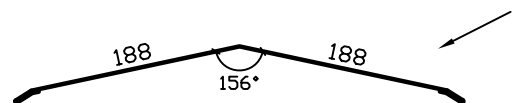
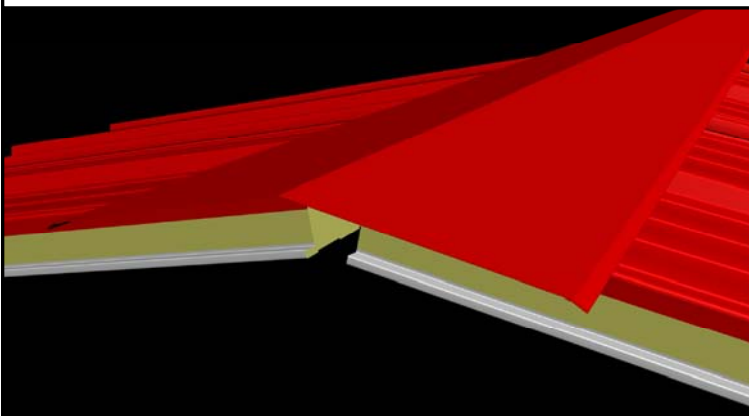
CUMBRERA LISA D416

DESARROLLO	416
LARGO	HASTA 6000
OBS.	

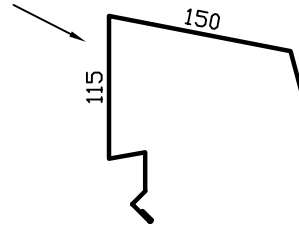
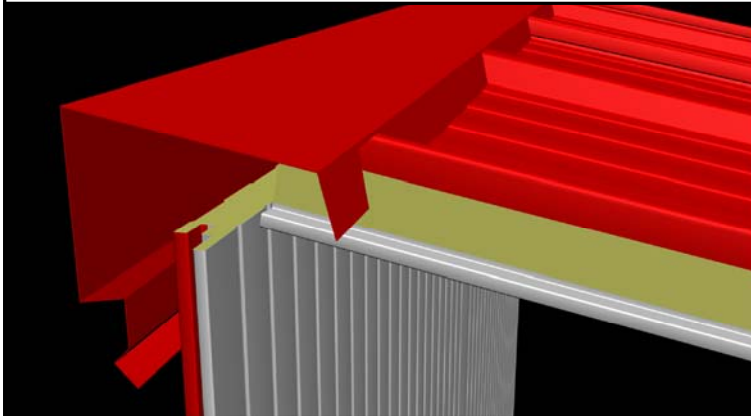
CORONACIÓN TRASERA TROQUELADA AIS TAP/3G/5G

DESARROLLO	407
LARGO	3200
OBS.	LARGO UTIL 3000

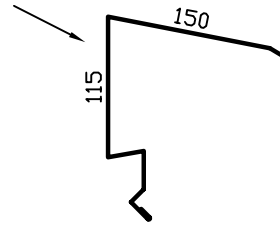
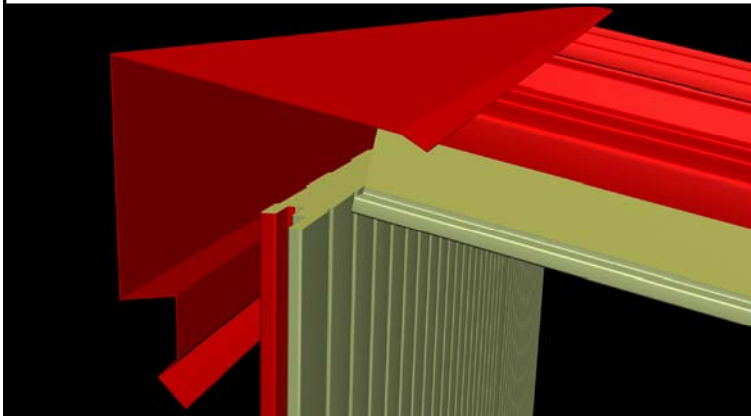
CORONACIÓN TRASERA SIN TROQUELAR

DESARROLLO	407
LARGO	HASTA 6000
OBS.	

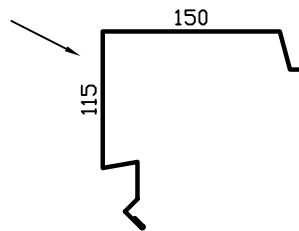
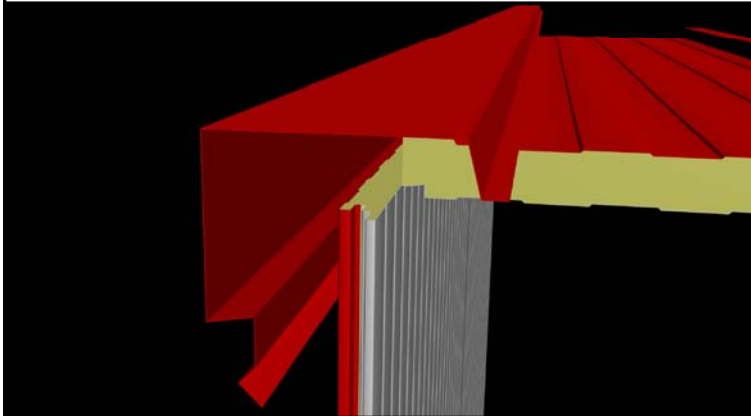
CORONACIÓN LATERAL AIS TAP/3G/5G

DESARROLLO	416
LARGO	HASTA 6000
OBS.	

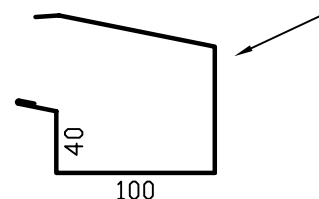
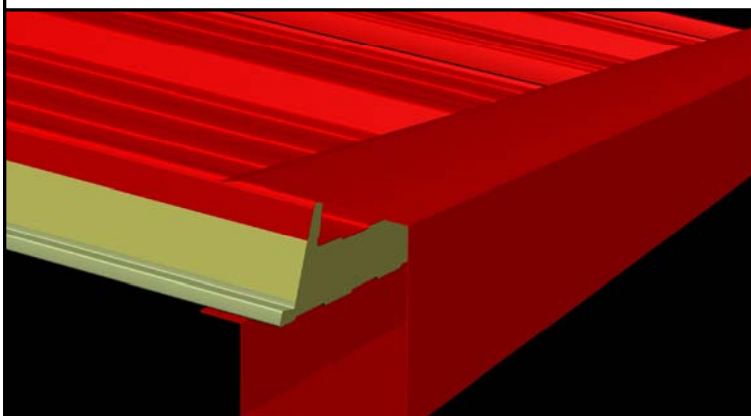
FRONTAL CANALON AIS TAP/3G/5G

DESARROLLO	HASTA 416
LARGO	HASTA 6000
OBS.	

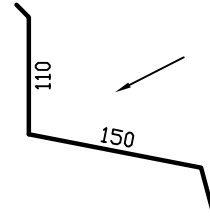
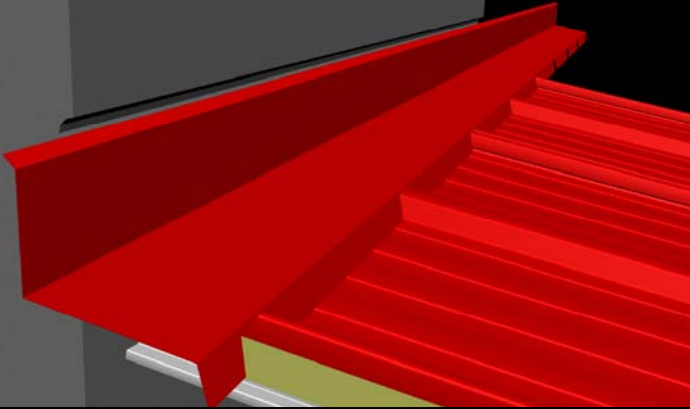
FALDON TRASERO TROQUELADO AIS TAP/3G/5G

DESARROLLO	303
LARGO	3200
OBS.	LARGO UTIL 3000

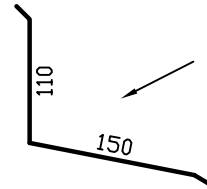
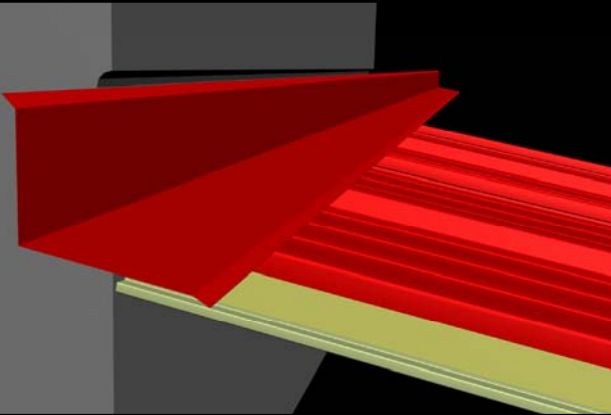
FALDON TRASERO SIN TROQUELAR

DESARROLLO	266
LARGO	HASTA 6000
OBS.	

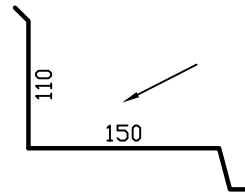
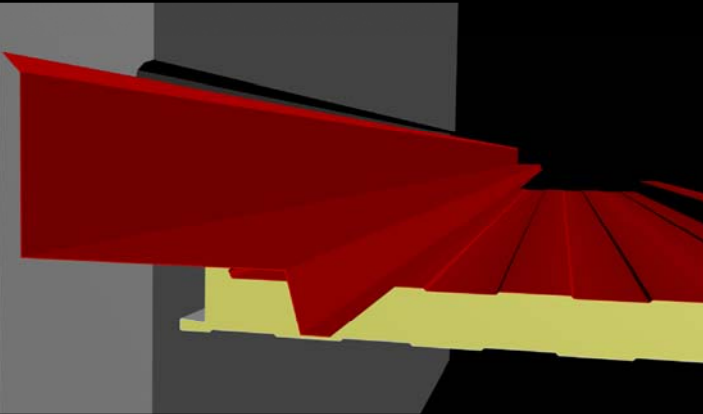
FALDON LATERAL AIS TAP 3G 5G

DESARROLLO	312
LARGO	HASTA 6000
OBS.	

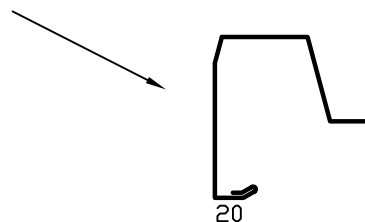
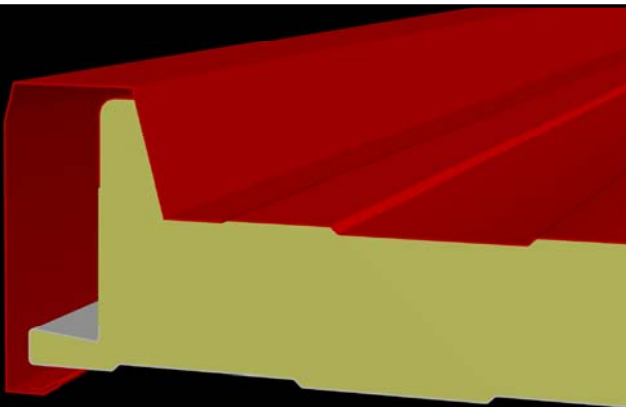
LATERAL VUELO AIS TAP 3G 5G

DESARROLLO	HASTA 218
LARGO	HASTA 6000
OBS.	

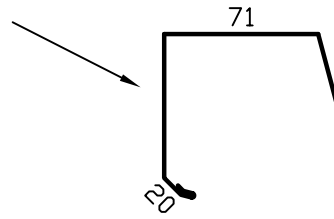
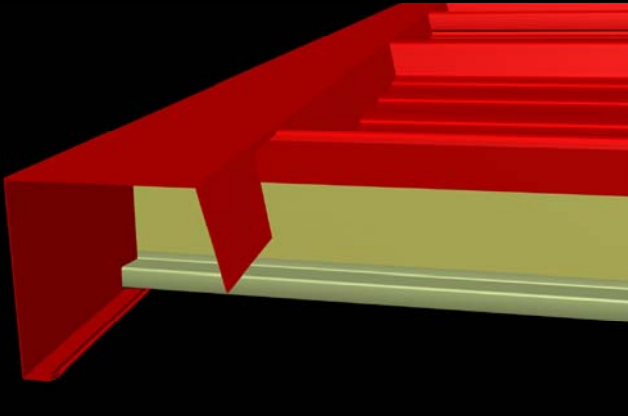
FRONTAL VUELO TROQUELADO AIS TAP

DESARROLLO	HASTA 250
LARGO	3200
OBS.	LARGO UTIL 3000

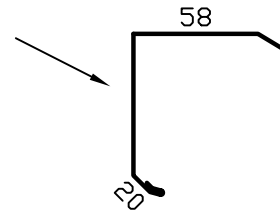
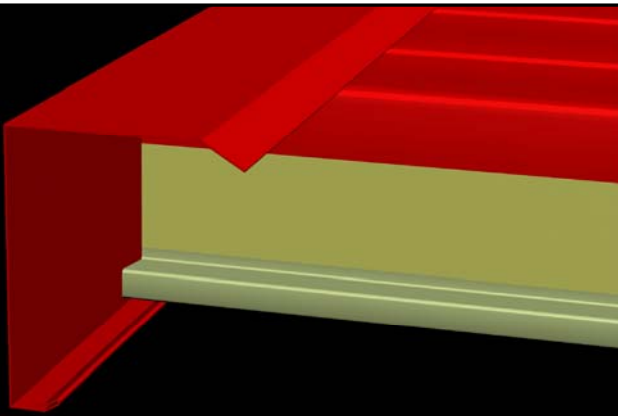
FRONTAL VUELO SIN TROQUELAR AIS 3G 5G

DESARROLLO	HASTA 250
LARGO	HASTA 6000
OBS.	

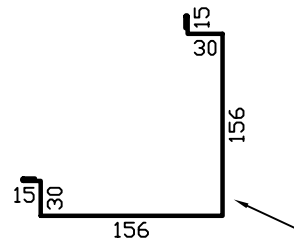
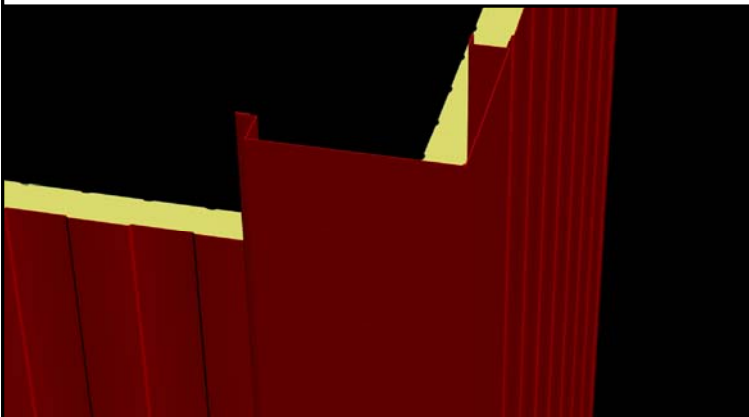
ESQUINERO EXTERIOR

DESARROLLO	416
LARGO	HASTA 6000
OBS.	

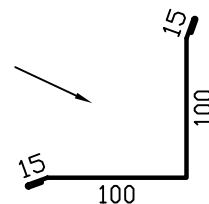
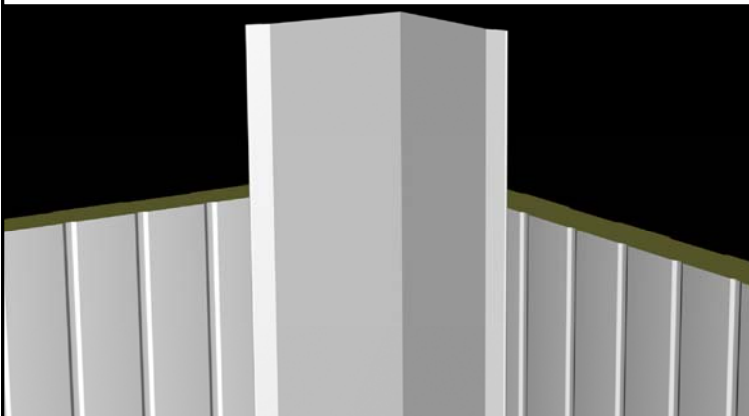
ESQUINERO INTERIOR

DESARROLLO	250
LARGO	HASTA 6000
OBS.	

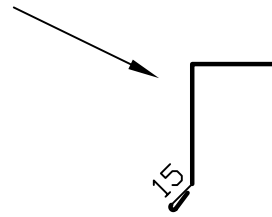
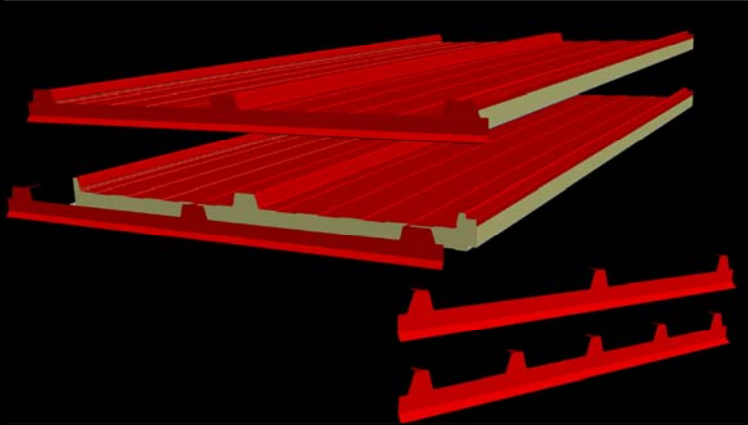
FRONTAL AIS TAP/3G/5G

DESARROLLO	
LARGO	1100
OBS.	LARGO UTIL - 1000

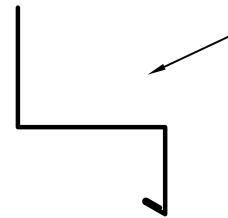
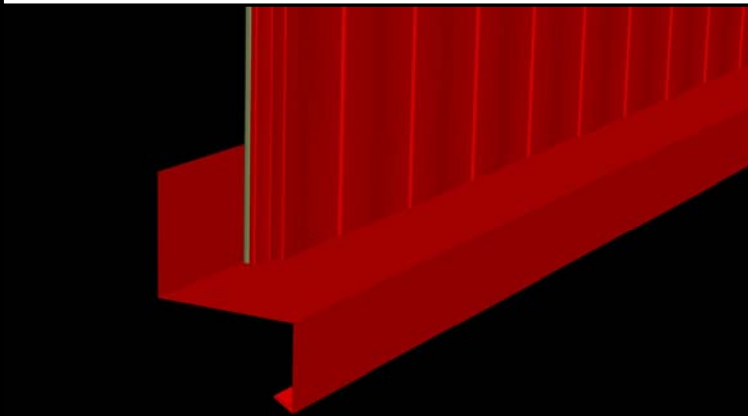
PIE FACHADA O VIERTEAGUAS

DESARROLLO	
LARGO	HASTA 6000
OBS.	

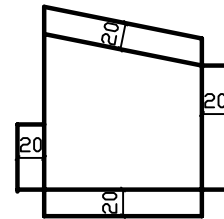
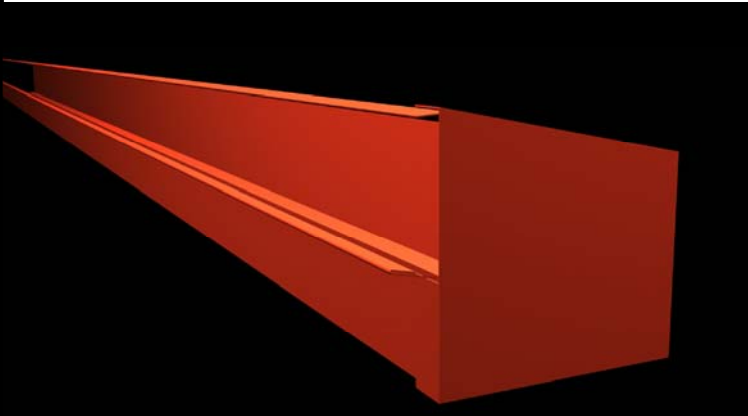
TAPA CANALÓN AIS TAP/3G/5G

DESARROLLO	
LARGO	
OBS.	

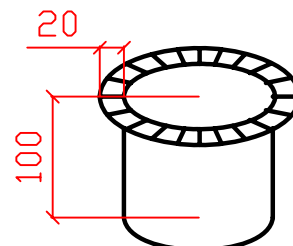
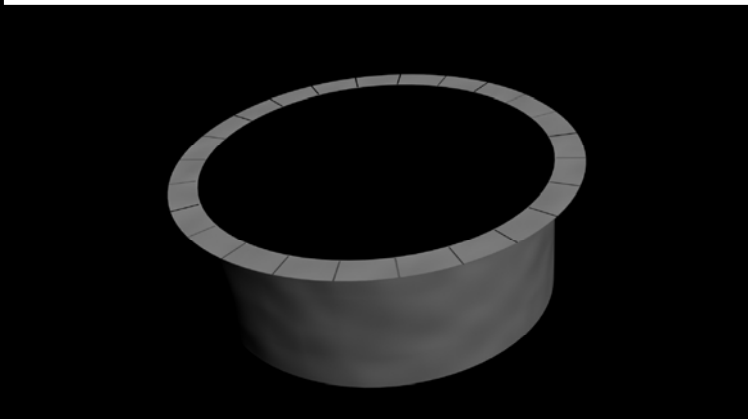
BOQUILLA BAJANTE CANALÓN

DESARROLLO	
LARGO	
OBS.	

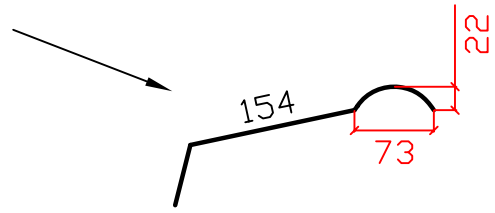
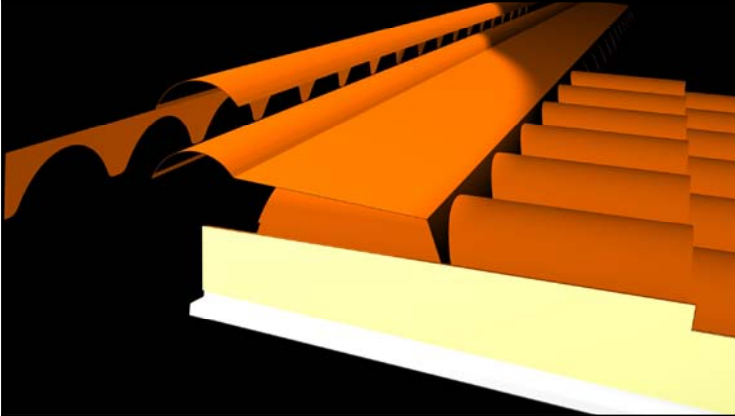
CUMBRERA DOBLE AIS COPPO

DESARROLLO	2x300
LARGO	2890
OBS.	LARGO UTIL 2720

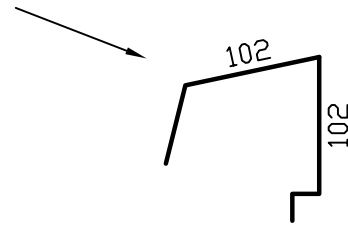
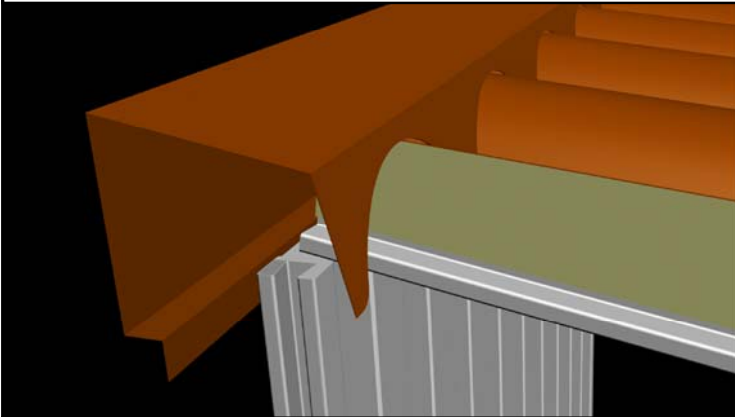
CORONACIÓN TRASERA TROQUELADA AIS COPPO

DESARROLLO	300
LARGO	2890
OBS.	LARGO UTIL 2720

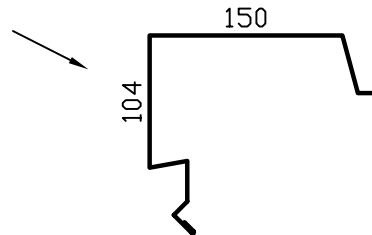
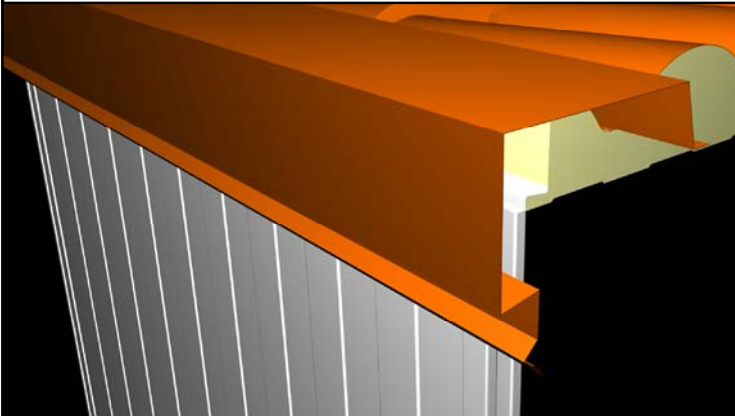
CORONACIÓN LATERAL AIS COPPO

DESARROLLO	416
LARGO	HASTA 6000
OBS.	

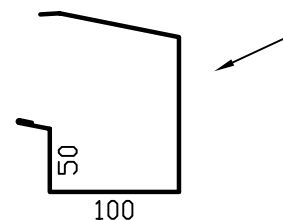
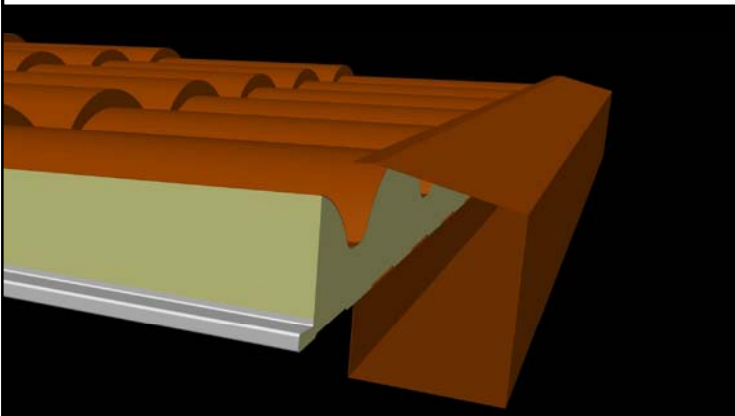
FRONTAL CANALÓN AIS COPPO

DESARROLLO	411
LARGO	HASTA 6000
OBS.	

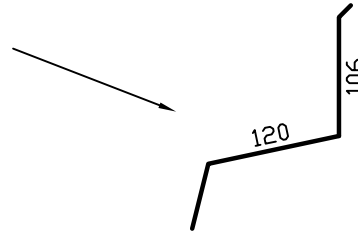
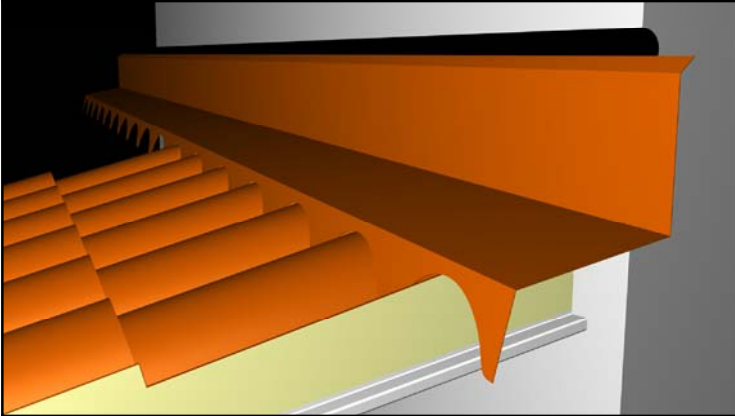
FALDÓN TRASERO TROQUELADO AIS COPPO

DESARROLLO	300
LARGO	2890
OBS.	LARGO UTIL 2700

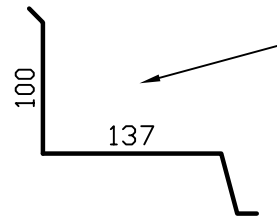
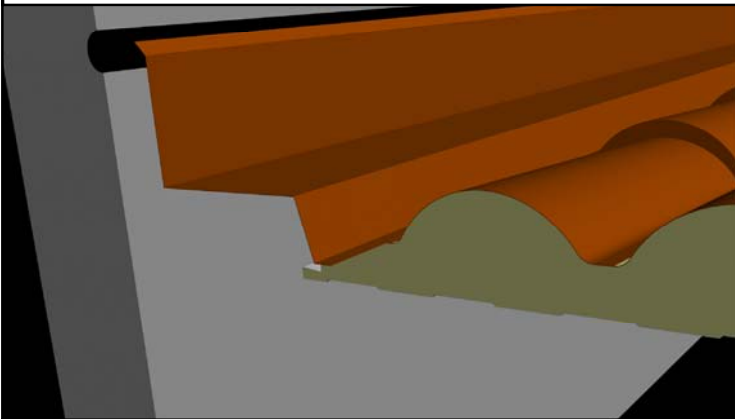
FALDÓN LATERAL AIS COPPO

DESARROLLO	312
LARGO	HASTA 6000
OBS.	

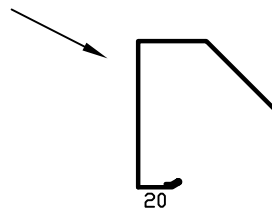
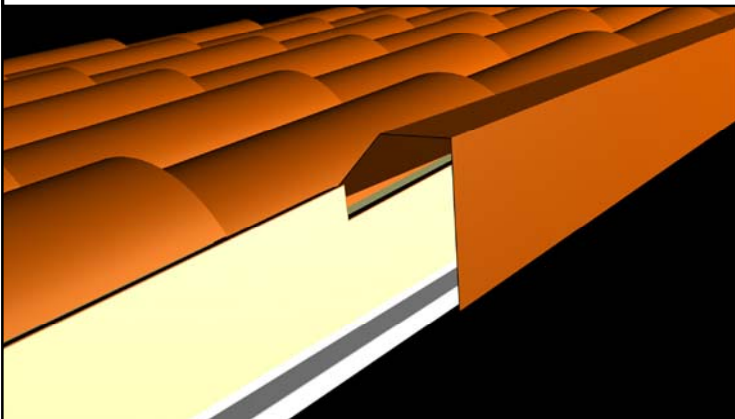
LATERAL VUELO AIS COPPO

DESARROLLO	228
LARGO	HASTA 6000
OBS.	

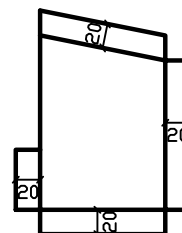
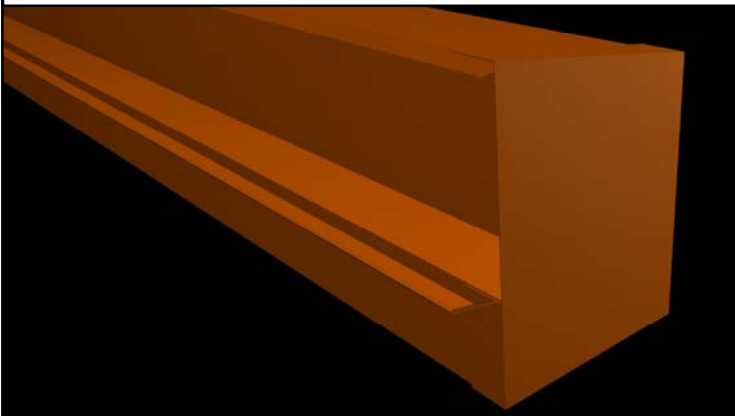
TAPA PARA CANALÓN DE COPPO

DESARROLLO	
LARGO	
OBS.	

REMATE FRONTAL AIS COPPO

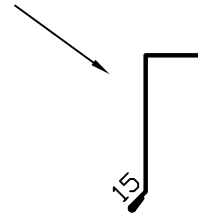
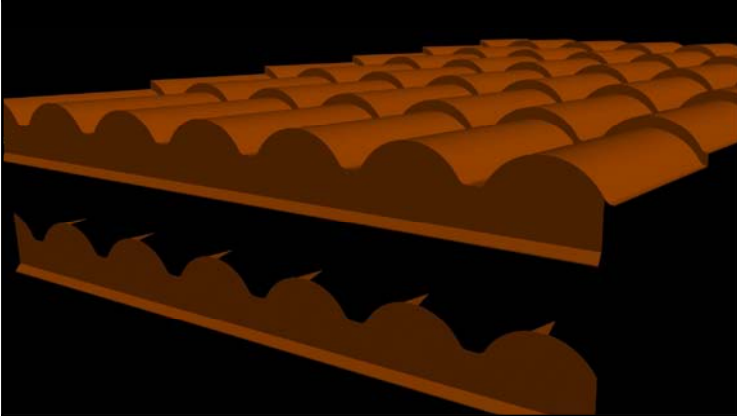

DESARROLLO	160
LARGO	1068
OBS.	LARGO UTIL 1000